

MUR6040

Preferred Device

SWITCHMODE™ Power Rectifier

... designed for use in switching power supplies, inverters and as free wheeling diodes, these state-of-the-art devices have the following features:

- Ultrafast 100 Nanosecond Recovery Time
- 175°C Operating Junction Temperature
- High Voltage Capability to 400 Volts
- Low Forward Voltage Drop
- High Temperature Glass Passivated Junction

Mechanical Characteristics:

- Case: Epoxy, Molded
- Weight: 4.3 grams (approximately)
- Finish: All External Surfaces Corrosion Resistant and Terminal Leads are Readily Solderable
- Lead Temperature for Soldering Purposes: 260°C Max. for 10 Seconds
- Shipped 30 Units Per Plastic Tube
- Marking: U6040

MAXIMUM RATINGS

| Rating | Symbol | Max | Unit |
|---|---------------------------------|-------------|------|
| Peak Repetitive Reverse Voltage Working Peak Reverse Voltage DC Blocking Voltage | V_{RRM} V_{RWM} V_R | 400 | V |
| Average Rectified Forward Current $T_C = 70^\circ\text{C}$ | $I_{F(AV)}$ | 60 | A |
| Peak Repetitive Forward Current (Rated V_R , Square Wave, 20 kHz, $T_C = 150^\circ\text{C}$) | I_{FRM} | 60 | A |
| Non-Repetitive Peak Surge Current (Surge Applied at Rated Load Conditions Halfwave, Single Phase, 60 Hz) | I_{FSM} | 600 | A |
| Operating Junction and Storage Temperature Range | T_J, T_{stg} | -65 to +175 | °C |



ON Semiconductor™

<http://onsemi.com>

**ULTRAFAST
RECTIFIER
60 AMPERES
400 VOLTS**

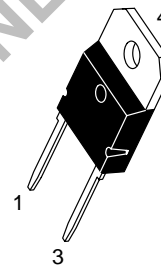

TO-218
CASE 340E
STYLE 1

MARKING DIAGRAM

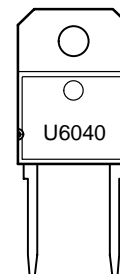

U6040 = Device Code

ORDERING INFORMATION

| Device | Package | Shipping |
|---------|---------|---------------|
| MUR6040 | TO-218 | 30 Units/Rail |

Preferred devices are recommended choices for future use and best overall value.

MUR6040

THERMAL CHARACTERISTICS

| Rating | Symbol | Max | Unit |
|--------------------------------------|-----------------|-----|---------------|
| Thermal Resistance, Junction to Case | $R_{\theta JC}$ | 0.8 | $^{\circ}C/W$ |

ELECTRICAL CHARACTERISTICS

| | | | |
|--|----------|------------|---------------|
| Instantaneous Forward Voltage (Note 1.) @ $I_F = 60$ Amps, $T_C = 100^{\circ}C$ @ $I_F = 60$ Amps, $T_C = 25^{\circ}C$ | V_F | 1.4 1.5 | Volts |
| Instantaneous Reverse Current (Note 1.) @ Rated dc Voltage, $T_C = 100^{\circ}C$ @ Rated dc Voltage, $T_C = 25^{\circ}C$ | I_R | 10 60 | mA μA |
| Reverse Recovery Time $I_F = 1.0$ Amp, $dI/dt = 15$ Amp/ μs | t_{RR} | 100 | ns |

1. Pulse Test: Pulse Width = 300 μs , Duty Cycle $\leq 2.0\%$

TYPICAL ELECTRICAL CHARACTERISTICS

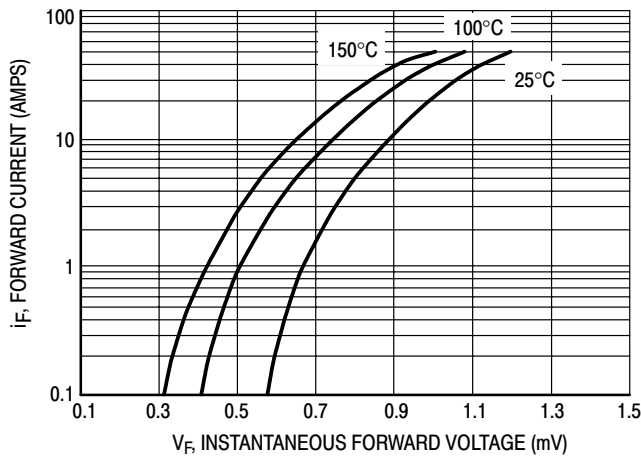

Figure 1. Typical Forward Voltage

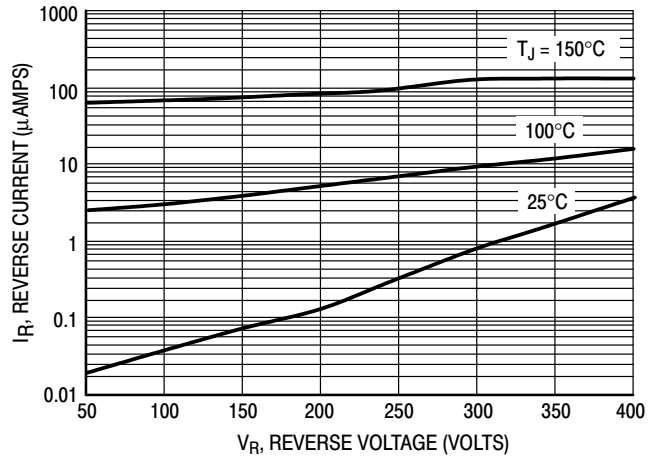

Figure 2. Typical Reverse Current

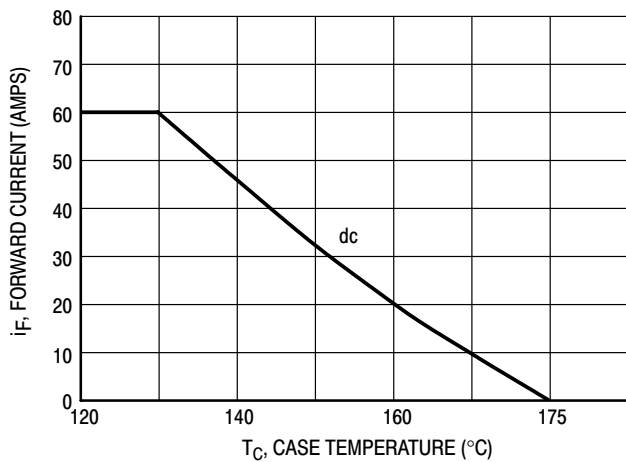

Figure 3. Current Derating, Case

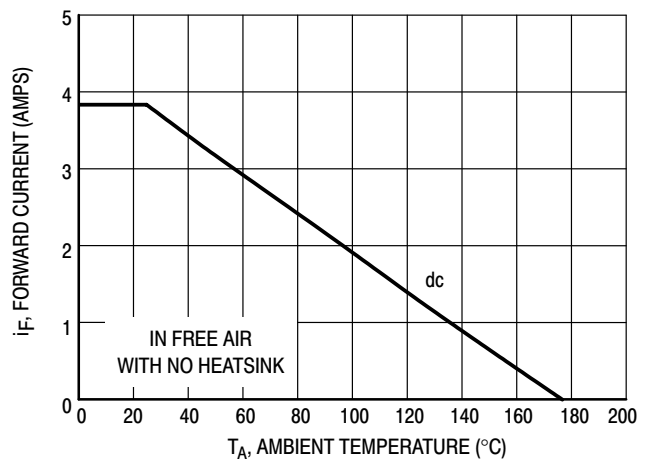
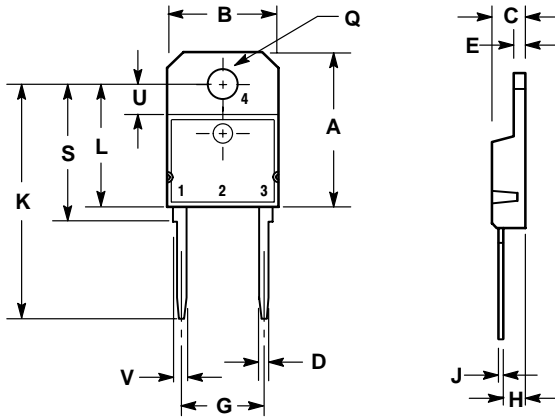

Figure 4. Current Derating, Ambient

MUR6040

PACKAGE DIMENSIONS

TO-218 TWO LEAD
TO-218
CASE 340E-02
ISSUE A



NOTES:

1. DIMENSIONING AND TOLERANCING PER ANSI Y14.5M, 1982
2. CONTROLLING DIMENSION: MILLIMETER.

| DIM | MILLIMETERS | | INCHES | |
|-----|-------------|-------|-----------|-------|
| | MIN | MAX | MIN | MAX |
| A | --- | 20.35 | --- | 0.801 |
| B | 14.70 | 15.20 | 0.579 | 0.598 |
| C | 4.70 | 4.90 | 0.185 | 0.193 |
| D | 1.10 | 1.30 | 0.043 | 0.051 |
| E | 1.17 | 1.37 | 0.046 | 0.054 |
| G | 10.80 | 11.10 | 0.425 | 0.437 |
| H | 2.00 | 3.00 | 0.079 | 0.118 |
| J | 0.50 | 0.78 | 0.020 | 0.031 |
| K | 31.00 REF | | 1.220 REF | |
| L | --- | 16.20 | --- | 0.638 |
| Q | 4.00 | 4.10 | 0.158 | 0.161 |
| S | 17.80 | 18.20 | 0.701 | 0.717 |
| U | 4.00 REF | | 0.157 REF | |
| V | 1.75 REF | | 0.069 | |

STYLE 1:

- PIN 1. CATHODE
- 3. ANODE
- 4. CATHODE

MUR6040

SWITCHMODE is a trademark of Semiconductor Components Industries, LLC.

ON Semiconductor and  are trademarks of Semiconductor Components Industries, LLC (SCILLC). SCILLC reserves the right to make changes without further notice to any products herein. SCILLC makes no warranty, representation or guarantee regarding the suitability of its products for any particular purpose, nor does SCILLC assume any liability arising out of the application or use of any product or circuit, and specifically disclaims any and all liability, including without limitation special, consequential or incidental damages. "Typical" parameters which may be provided in SCILLC data sheets and/or specifications can and do vary in different applications and actual performance may vary over time. All operating parameters, including "Typicals" must be validated for each customer application by customer's technical experts. SCILLC does not convey any license under its patent rights nor the rights of others. SCILLC products are not designed, intended, or authorized for use as components in systems intended for surgical implant into the body, or other applications intended to support or sustain life, or for any other application in which the failure of the SCILLC product could create a situation where personal injury or death may occur. Should Buyer purchase or use SCILLC products for any such unintended or unauthorized application, Buyer shall indemnify and hold SCILLC and its officers, employees, subsidiaries, affiliates, and distributors harmless against all claims, costs, damages, and expenses, and reasonable attorney fees arising out of, directly or indirectly, any claim of personal injury or death associated with such unintended or unauthorized use, even if such claim alleges that SCILLC was negligent regarding the design or manufacture of the part. SCILLC is an Equal Opportunity/Affirmative Action Employer.

PUBLICATION ORDERING INFORMATION

Literature Fulfillment:

Literature Distribution Center for ON Semiconductor
P.O. Box 5163, Denver, Colorado 80217 USA
Phone: 303-675-2175 or 800-344-3860 Toll Free USA/Canada
Fax: 303-675-2176 or 800-344-3867 Toll Free USA/Canada
Email: ONlit@hibbertco.com

N. American Technical Support: 800-282-9855 Toll Free USA/Canada

JAPAN: ON Semiconductor, Japan Customer Focus Center
4-32-1 Nishi-Gotanda, Shinagawa-ku, Tokyo, Japan 141-0031
Phone: 81-3-5740-2700
Email: r14525@onsemi.com

ON Semiconductor Website: <http://onsemi.com>

For additional information, please contact your local Sales Representative.